

Standard Custom Electro-Mechanical Switches

DC-12.4 GHz, Type N and TNC

DP2T Series 132 Transfer Switch

RF Performance

Freq. Range (GHz)	DC-3	3-8	8-12.4
VSWR (max.)	1.2	1.35	1.5
Insertion Loss (dB max.)	0.2	0.35	0.5
Isolation (dB min.)	80	70	60



Additional Specifications

RF Impedance..... 50 ohms nominal
 Actuating Voltage*..... 28 Vdc
 Actuating Current* Failsafe: 360 mA (max.)
 Latching: 360 mA (max.)
 Switching Time..... 20 ms (max.)
 Switching Sequence..... Break Before Make
 Operating Ambient Temperature..... -35°C to +70°C
 Operating Life..... 1 Million Cycles per Position

* Specifications for 28 Vdc, 25°C

NOTES:

Designed to meet MIL-S-3928.
 Power Handling shown on page 235.

Options Available (refer to pages 231-232)

GROUP 2 ACTUATION

- A - FAILSAFE
- B - LATCHING

GROUP 3 OPTIONS

- 0 - NONE
- 2 - INDICATOR CIRCUITRY
- 3 - SUPPRESSION DIODES
- 4 - TTL LOGIC HIGH
- 7 - SELF DE-ENERGIZING CIRCUITRY
- 9 - OTHER (SPECIFY)
- V - MOSFET DRIVER

GROUP 4 RF CONNECTORS

- D - TYPE N
- E - TNC
- G - OTHER (SPECIFY)

GROUP 5 TERMINALS

- 1 - SOLDER (STANDARD)
- 2 - POWER CONNECTOR, FAST DISCONNECT (STANDARD MIL)
- 3 - POWER CONNECTOR, FAST DISCONNECT (SUB MIN. "D")
- 4 - SOLDER (LOOP)
- 5 - OTHER (SPECIFY)

GROUP 6 VOLTAGE

- B - 12 VDC
- C - 24 VDC
- D - 28 VDC
- E - 48 VDC
- G - OTHER (SPECIFY)
- H - 15 VDC
- I - 18 VDC

GROUP 7 FREQUENCY

- 0 - DC - 1 GHz
- 1 - DC - 3 GHz
- 2 - DC - 8 GHz
- 3 - DC - 12.4 GHz
- 7 - OTHER (SPECIFY)

GROUP 8 POLARITY

- A - COMMON PLUS
- B - COMMON MINUS
- C - NOT RELEVANT TO APPLICATION OR SWITCHES WITH LOGIC

GROUP 9 MOUNTING

- 0 - STANDARD MOUNTING HOLES
- 1 - BRACKET
- 3 - OTHER (SPECIFY)

Switch Height (A) for Selected Options

DIM A ±.03	GROUP 2 ACTUATION	GROUP 3 OPTIONS
2.13	A, D	0,2,3,4 or 5,V
2.13	B	0,2,3,4 OR 5,7,V
2.63**	B	0,2,3,4 OR 5,7,V
2.63**	A, D	0,2,3,4 OR 5,V

** Dimension for switches with Standard Narda Power Connector MS3112E-12-8P mating with MS3116E-12-8S

Standard Custom Electro-Mechanical Switches

Typical Schematics

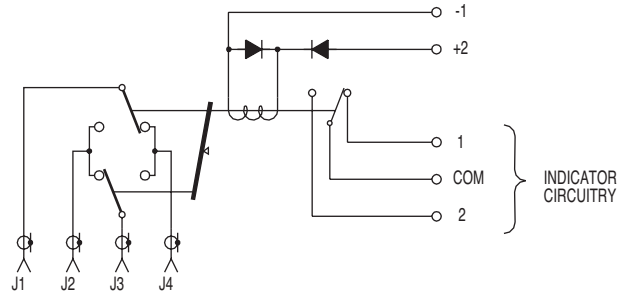

SCHEMATIC SHOWN IN FAILSAFE POSITION

Failsafe, Common Plus DP2T Switch
with indicator circuitry and suppression diodes (A23)

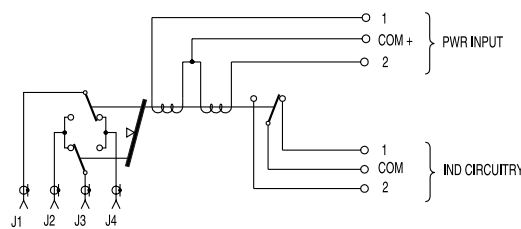
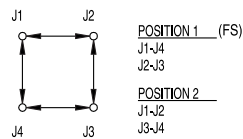

SCHEMATIC SHOWN WITH POSITION 1 CLOSED

Latching, Common Plus DP2T Switch
with indicator circuitry (B2)

Standard Custom Electro-Mechanical Switches

Outline Drawings

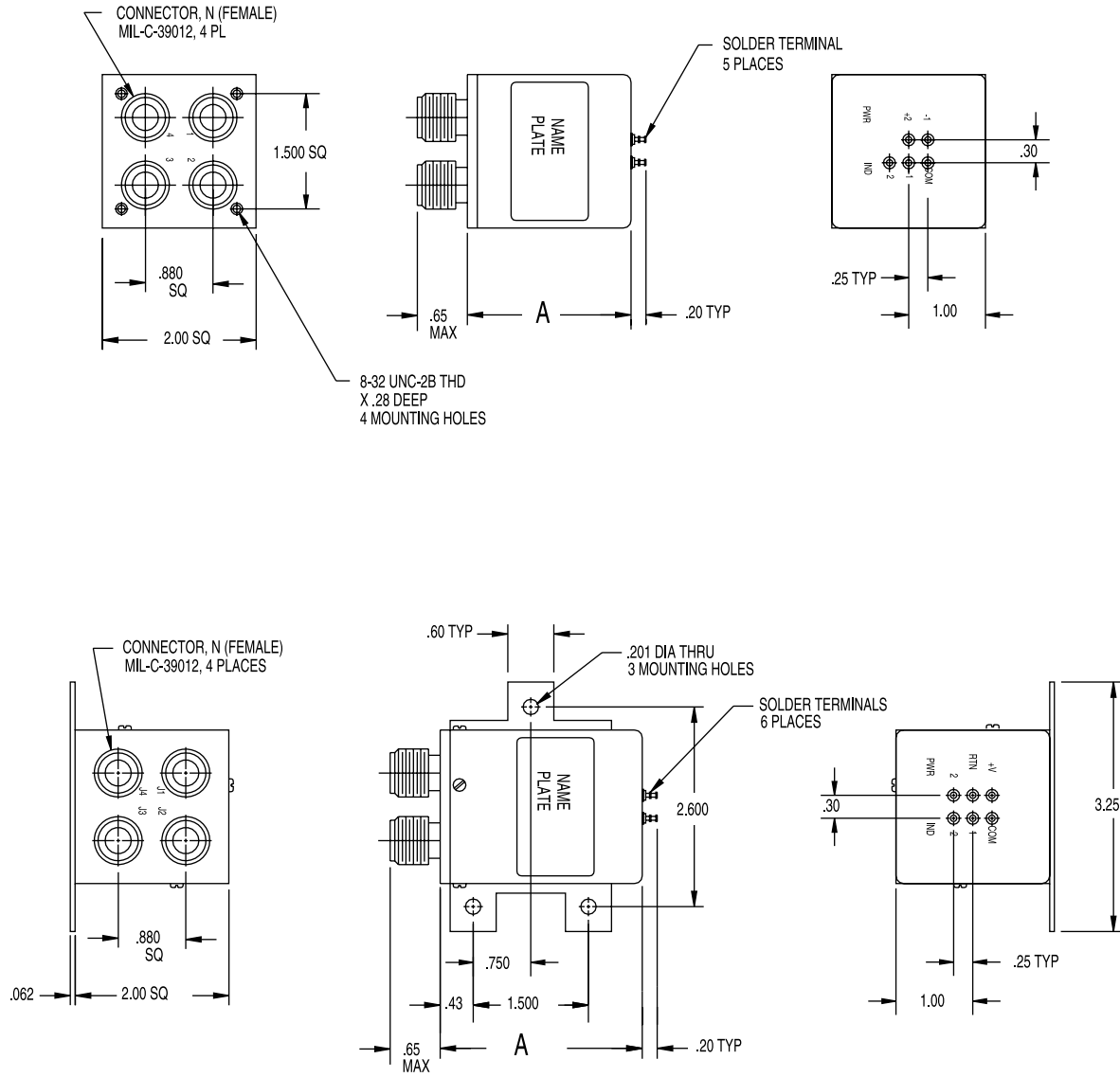

Dimensions in inches, unless otherwise specified.

Standard Custom Electro-Mechanical Switches

Custom may now be Standard

We believe your first choice should be Narda's standard SEM switch series – even if you have always ordered custom-part switches. Narda has more standard switches than any company in the industry. Please review our expanded line of stocked SEM switches before placing a custom order.

But, if standard still won't do...

It's easy to determine the number of a custom pick Narda switch that will correctly satisfy your intended application. Simply use the Part Number Chart on the next page. Referring to this chart, sequentially select the desired switch characteristics and options from Group 1 through Group 9.

Within each group, select the number or letter representing the desired configuration or feature and record it in the manner shown by the "typical part number" on the chart. (The open boxes below are provided to assist you in using the part numbering process.)

Note that the last digit in part number Group 1 is indicative of envelope size and requires reference to the individual specifications and drawings in this catalog.

Select only one character from each part number group except for the Group 3 options. In Group 3, you may select as many options as applicable.

In Group 1, four items identified as "series number modifiers" call for further explanation:

6XXX - If a matrix type switch is required, precede the selected series number with modifier number "6" (for example, specify 6080 for an eight position matrix switch).

8XXX - If you are able to configure a required switch from the features and options listed here, but will be imposing your own design or test specification, precede the selected series number with modifier number "8" to indicate to us that our standard switch may require special treatment.

9XXX - When a deviation from a standard design is required (for example, painted housing instead of black anodized), precede the selected series number with the number "9." Then contact your Narda Regional Sales Manager.

To confirm that desired options are available for the selected switch series, please refer to the individual switch specifications in this catalog. Any other question that may arise in determining the proper part number should be addressed to your Narda Regional Sales Manager.

Part Number Grouping (see next page for part number charts)

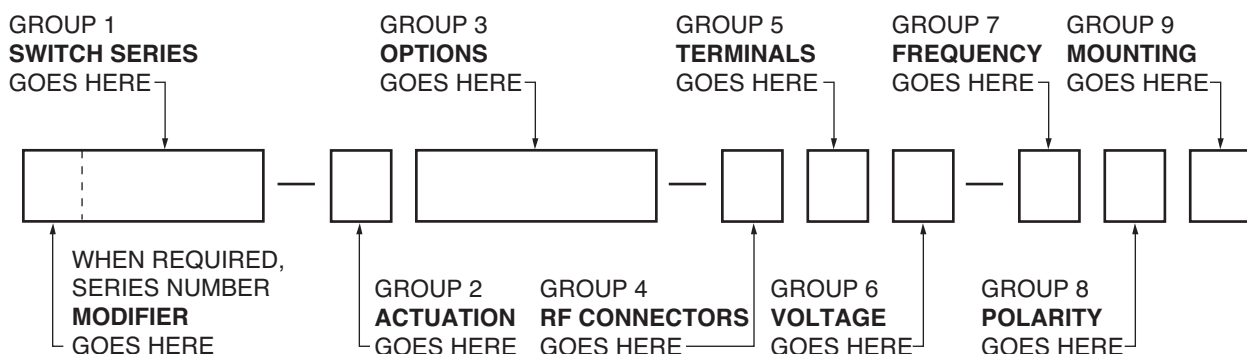

Standard Custom Electro-Mechanical Switches

Part Number Charts

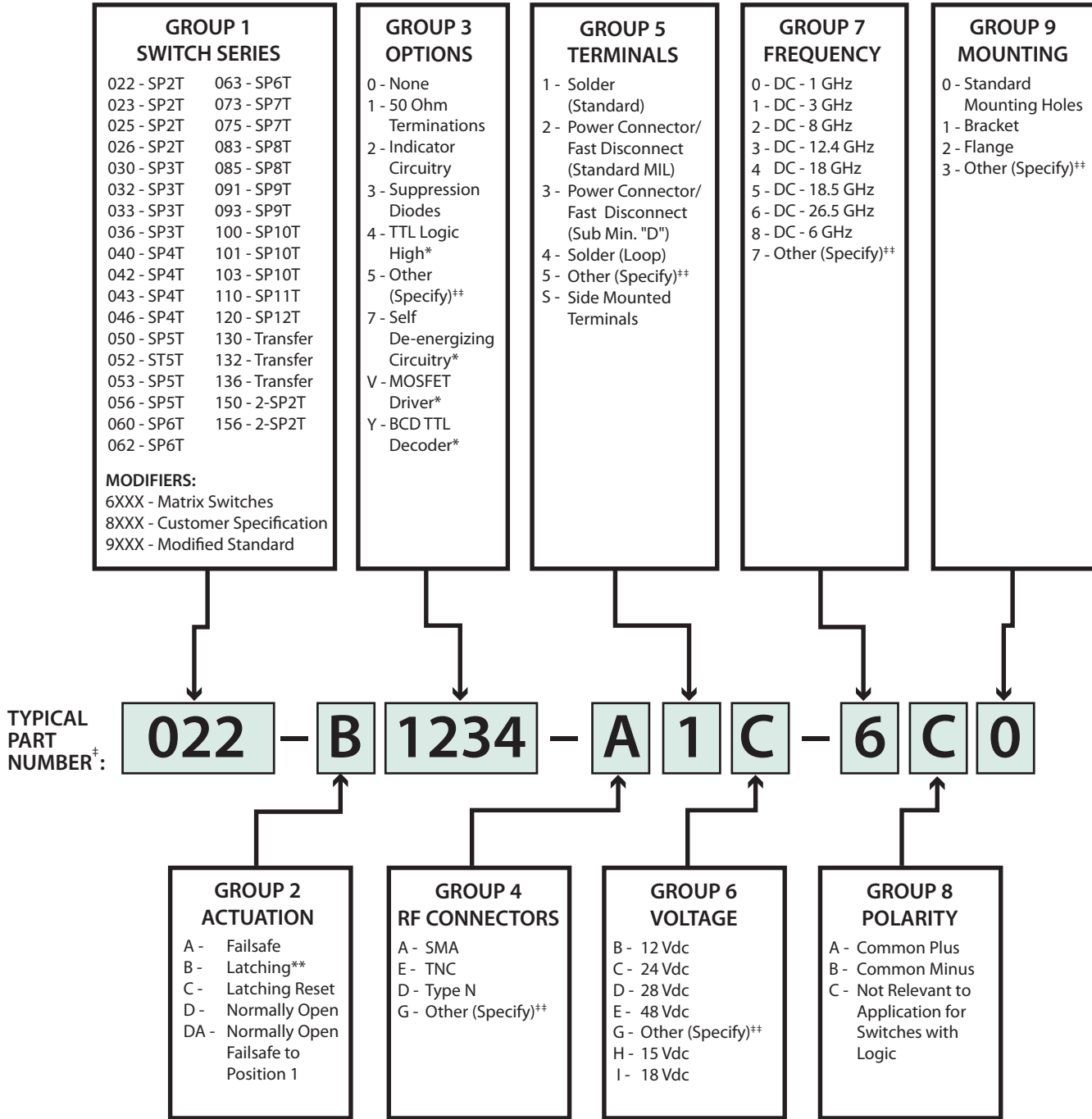

* If this option is selected, suppression diodes (option 3) must also be selected

** Requires pulse control of duration 30 to 100 ms unless self de-energizing circuitry option is chosen; Self de-energizing circuitry is recommended for multi-throw switches

† Sample Part Number identifies: SP2T switch, latching, 50 ohm termination, indicator circuitry, suppression diodes, TTL logic, SMA connectors, solder terminals, 24 Vdc, DC-26.5 GHz, polarity not relevant

** Consult the factory if "Other" is specified in any field



Standard Custom Electro-Mechanical Switches

Glossary

The following glossary defines the various options and features available on Narda switches. All Switches are bi-directional. Inputs and Outputs are interchangeable.

SP2T Switch - A single pole, double throw switch has one input port and two selectable output ports.

Multiposition Switch - A multiposition switch has one input port and more than two selectable output ports. Standard Narda switches offer up to 12 outputs operating from a single input. Unlike some switch designs, Narda multiposition models can be switched directly to any one of the available output positions without sequencing through any intervening positions.

Transfer Switch (DP2T) - A transfer switch has two independent paths that operate simultaneously in either of two selected positions.

Failsafe - A mode of operation in which the switch moves to the closed position when the actuating voltage is applied and always returns to a predetermined position when the voltage is removed.

Hot Switching - A mode of operation where a high power RF signal is continually applied to the RF contacts while the switch is changing positions. It must be noted that switch life is a factor in this type of operation (1 Watt max.).

Latching - Also called pulsed latching, a mode of operation in which the switch remains in a preselected position whenever the actuating voltage is removed or interrupted and holds that preselected position until a voltage is applied to another position. *Latching switches specified without self de-energizing circuitry require pulse control, with pulse duration of 30 to 100 ms.*

Latching Reset - A mode of operation in which the switch remains in the pre-selected position whenever the actuating voltage is removed or interrupted. However, switching to a new position cannot occur until a voltage has been applied to the reset terminal to open all closed switching positions. This reset mode then permits random selection of any desired switch position and guarantees clean break before make switching.

Normally Open - A mode of operation in which all output ports of the switch are disconnected from

the input port until a voltage is applied to maintain a selected position. The switch returns to its open position with the removal of voltage.

Normally Open Failsafe to Position 1 - In this mode of operation, (available only on multiposition switches), Position 1 is always closed until another switch position has been selected.

50 Ohm Termination - With this option, each unused or open output RF port is internally terminated in a 50 ohm resistive load. 1 W CW per position max.; 5 W CW max. input total per switch.

Indicator Circuitry - With the indicator circuitry option, a set of internally mounted contacts allow external monitoring of switch RF status.

Suppression Diodes - With this option, fast-recovery silicon rectifiers (diodes) are connected in parallel with the coils of the switch to suppress any transient voltage generated by the coils.

TTL - Selected position of the switch is controlled by a TTL Logic High. The switch requires only nominal +28 Vdc (additional 5 Vdc is not required).

TTL Logic Voltage Level:

Low 0 to 0.8 Vdc

High 2.5 to 5.0 Vdc

TTL Logic Input Current:

Low 0 mA

High 1.6 mA max. @ 3.85 Vdc

TTL Logic, High Input - Completely contained within the switch housing, this Transistor-Transistor-Logic driver circuitry enables the status of the switch to be controlled by the high level of the TTL logic input.

Self De-energizing Circuitry - With this option, a set of internally mounted contacts or electronically generated pulses disconnects the driver voltage as soon as RF contact has been made. This option is only available with latching type switches. Suppression diodes must be specified with this option.

Power Handling Capability (Watts CW) - Several factors determine the power handling capability of a given switch design. A general indication of power capability versus frequency is shown on the next page.

Standard Custom Electro-Mechanical Switches

BCD TTL Decoder - Completely contained within the switch housing, BCD logic circuitry establishes compatibility of the switch with binary logic inputs.

MOSFET Driver - Completely contained within the switch housing, the MOSFET driver establishes compatibility of the switch with external CMOS (15 Vdc) control logic. This type of driver can be controlled by any DC voltage from 3 Vdc up to 15 Vdc. A MOSFET circuit is switched with voltage and requires virtually no current. Also, it does not require a separate +5 Vdc power supply.

Standard Solder Terminal - The standard solder terminal offered with switches is a gold plated, double turret terminal, as shown in Figure 1.

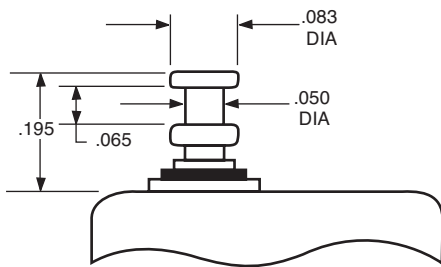

Figure 1. Standard Solder Terminal

Solder (Loop) Terminal - As an option, Narda offers a glass to metal loop type solder terminal, as shown in Figure 2.

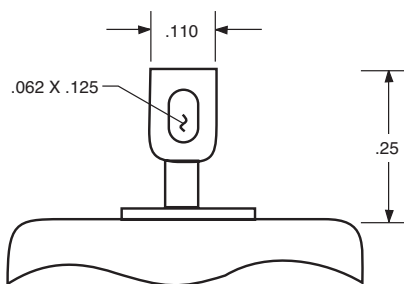

Figure 2. Optional Loop Type Solder Terminal

Power Connector / Fast Disconnect - The standard power connectors offered with Narda switches are specified on the individual data sheets in this catalog. Narda

switches can also be supplied with other power connectors specified by the customer.

Polarity - Either common plus polarity or common minus polarity must always be specified when ordering the following switches:

- Latching
- Latching Reset
- Latching with Self De-energizing Circuitry
- Latching Reset with Self De-energizing Circuitry
- Make Before Break
- Normally Open with Suppression Diodes
- Failsafe with Suppression Diodes
- Normally Open Failsafe to Position 1 with Suppression Diodes
- Indicators

Polarity is not relevant to application for switches listed as follows:

- Normally Open – No Options
- Failsafe – No Options, except for XSEM323 or 130 Series
- Switches with TTL logic driver, BCD decoder or MOSFET driver

Actuator Voltage - Standard Narda DC actuating voltages are 12, 15, 18, 24, 28 and 48. When other voltages are required, contact your Narda Regional Sales Manager for instructions (page 354).



Standard Custom Electro-Mechanical Switches

Power Handling Capability

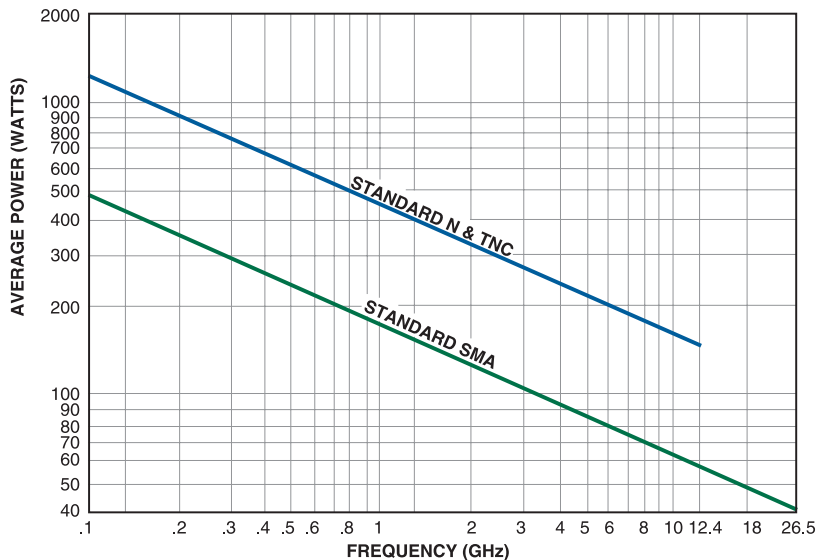

Power Handling Capability of Narda Switches vs. Frequency for Common RF Connectors
(for 25°C ambient temperature, matched 50ohm systems, sea level and cold switching)

For VSWR above 1.1, Derate Power Handling Capability as shown:

VSWR	Derating Factor
1.5	.94
2.0	.88
2.5	.83
3.0	.78
3.5	.73
4.0	.70

